

Zatęszon. k. nr. 1.
do umocowy.

kpl-1

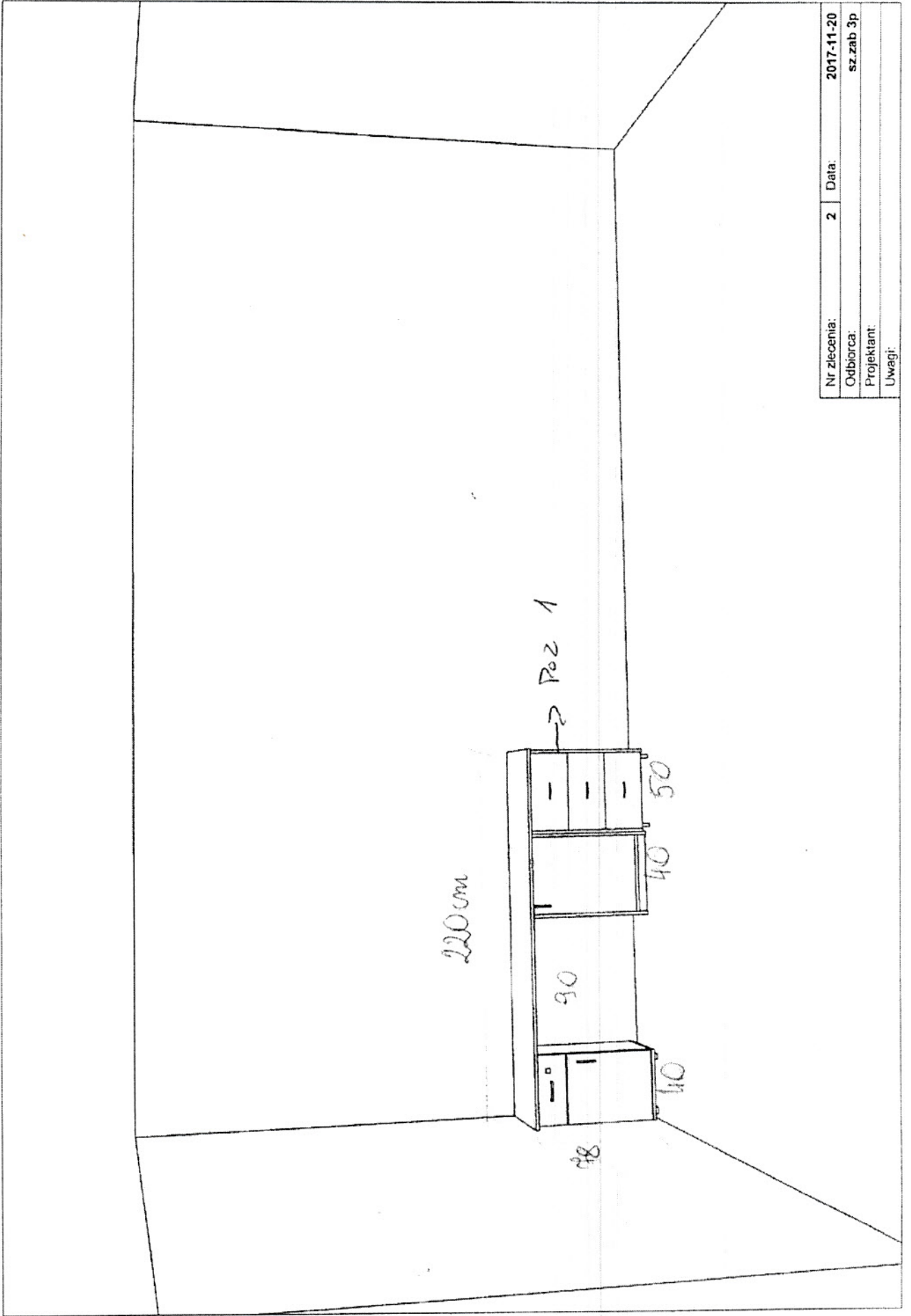

Nr zlecenia:	2	Data:	2017-11-20
Odbiorca:	sz.zab 3p		
Projektant:			
Uwagi:			

KPL - 1 zadecznik nr. 1
o wym. 235 cm

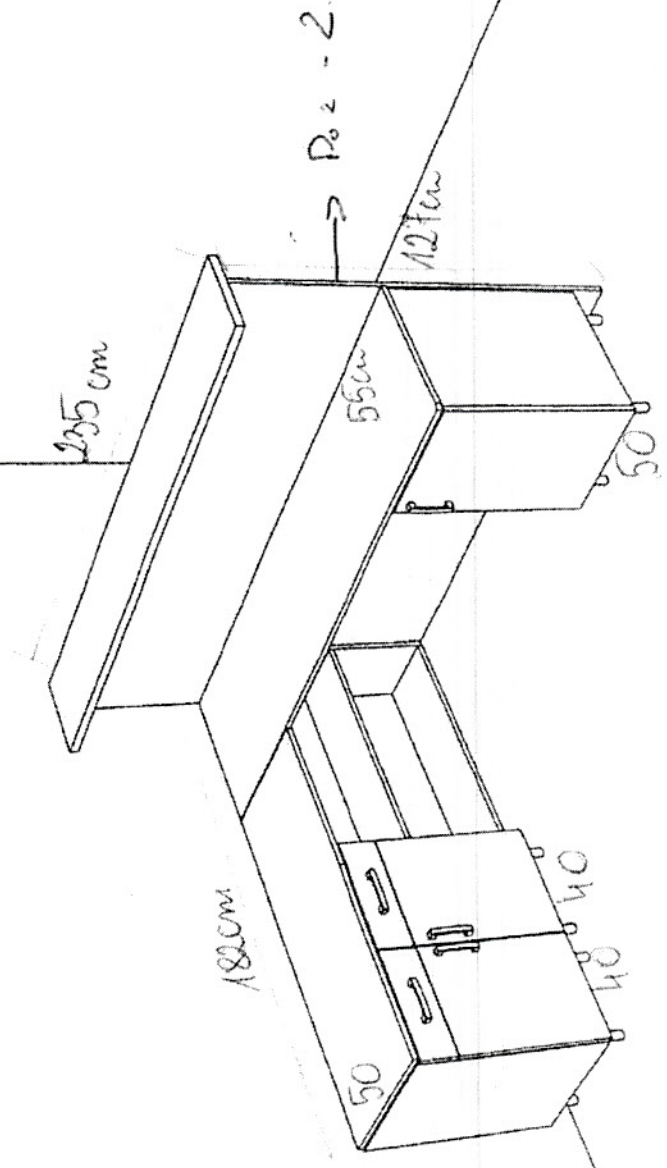

Nr zlecenia:	3	Data:	2017-11-20
Odbiorca:	sz.kon 3 piętro		
Projektant:			
Uwagi:			

KPL - 1

Zakaznik

ni. 1

do umowy.

350cm

Poz 3

Poz 4. 190cm

45cm

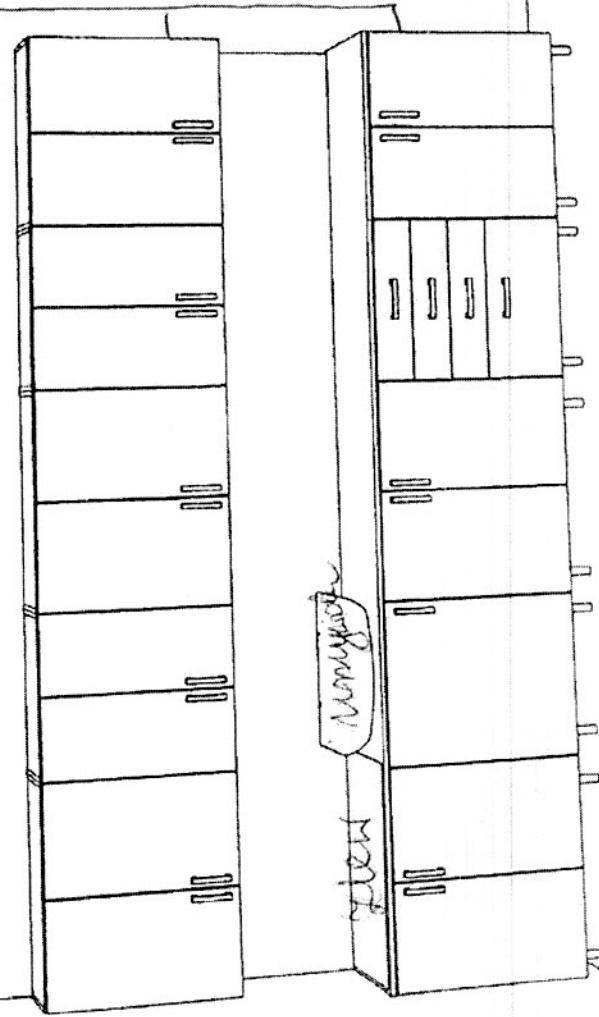
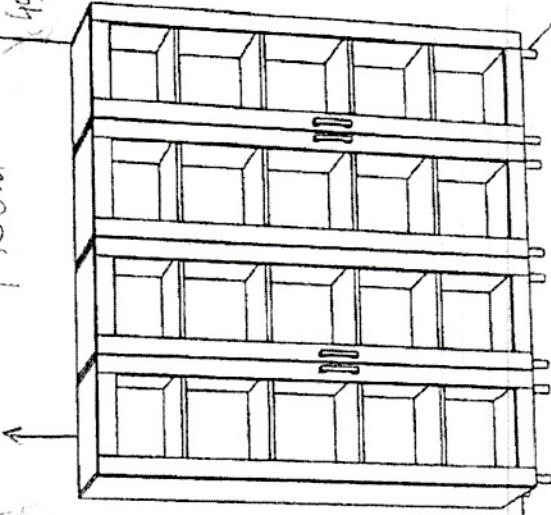

Nr zlecenia:	2017-11-20
Odbiorca:	zab. 3 piętro
Projektant:	
Uwagi:	

kpl-2

zatręcenie

m. 1.00 umowy.

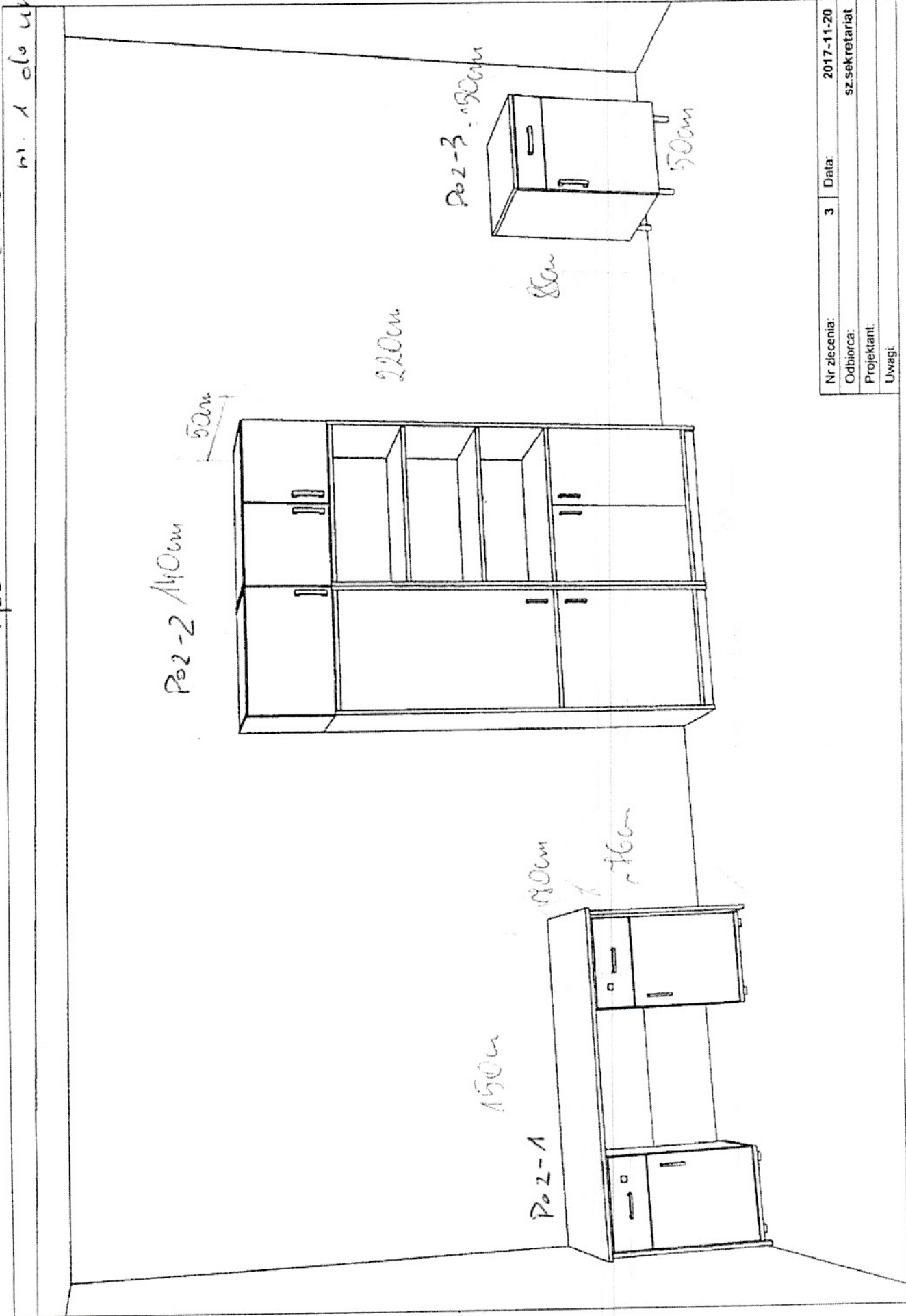

Nr zlecenia:	3	Data:	2017-11-20
Odbiorca:	sz.sekretariat		
Projektant:			
Uwagi:			

Kpl-3

Zatręcenie nr. 1 do umowy.

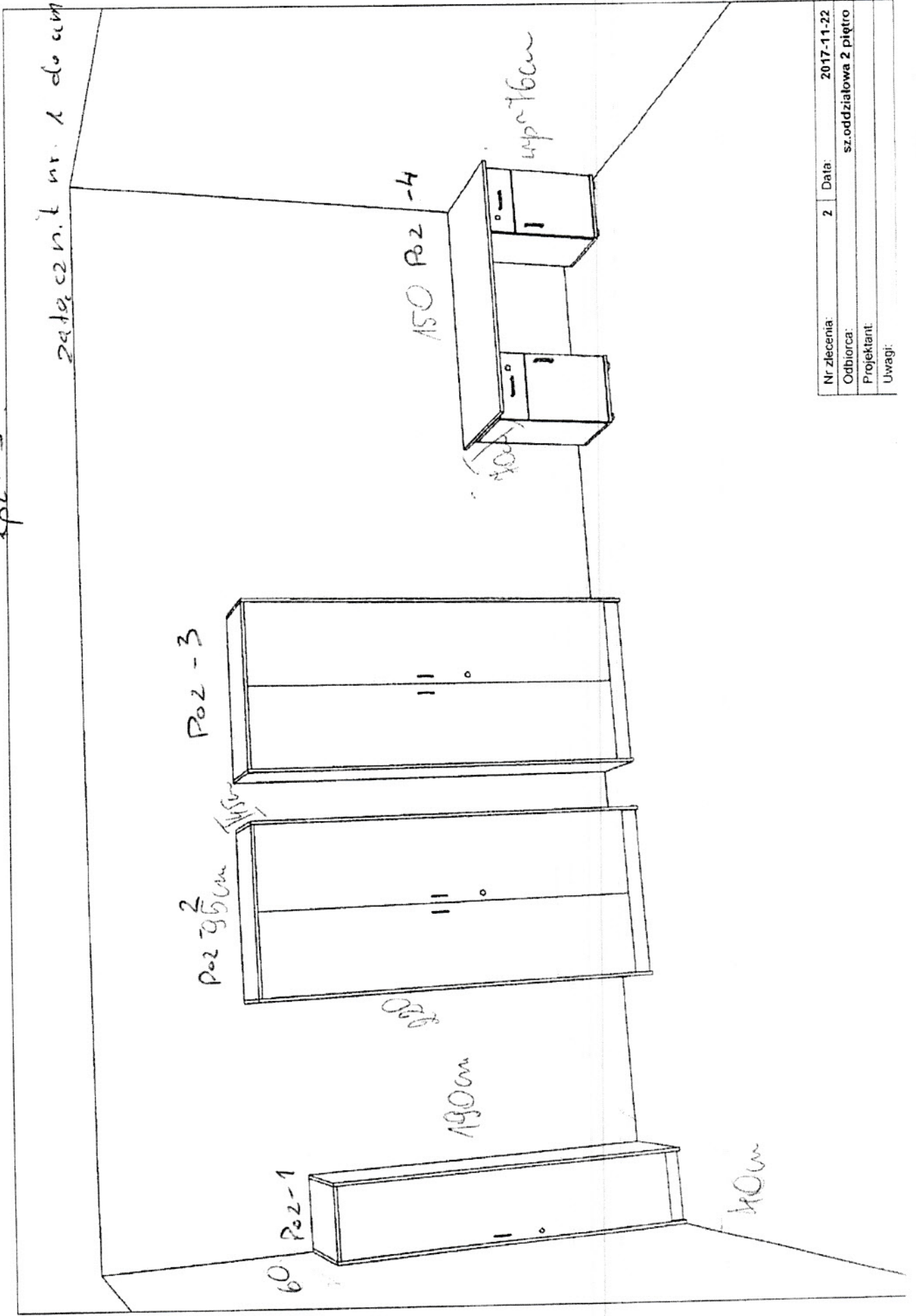

Nr zlecenia:	2	Data:	2017-11-22
Odbiorca:	sz. oddziałowa 2 piętro		
Projektant:			
Uwagi:			

KPL - H
zastosowanie

nr. 1 do umowy

Poz-2 180cm

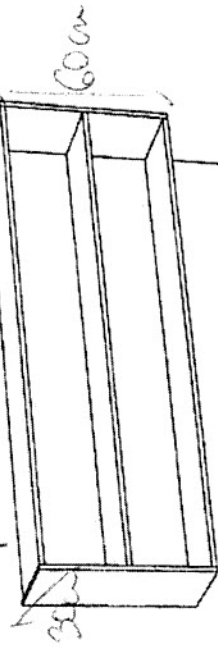

140 Poz-3

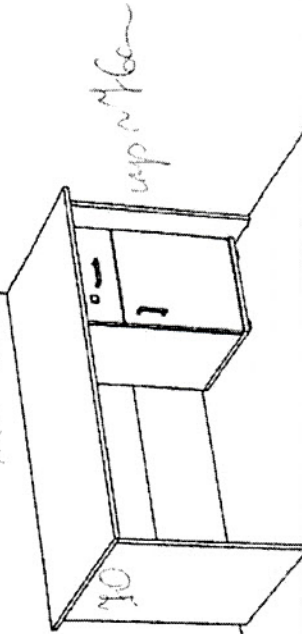

90cm Poz-1 80

60cm

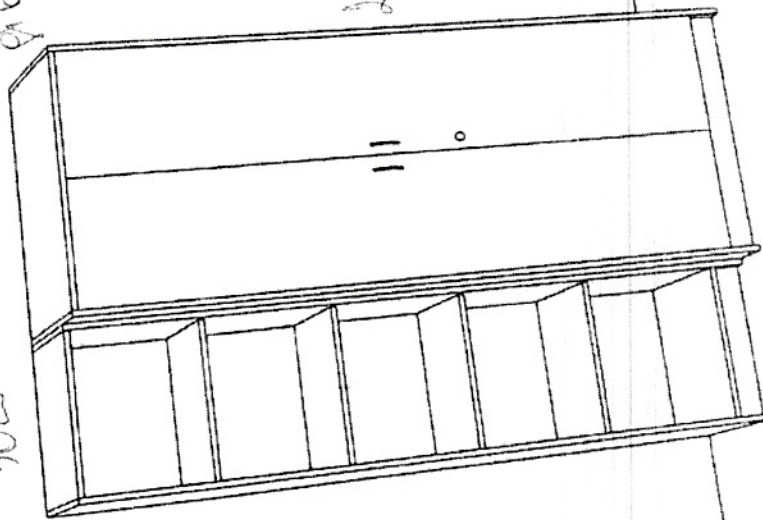

Nr zlecenia:	Data:	2017-11-22
Odbiorca:	sz.szoł	
Projektant:		
Uwagi:		